

HYBRID

*Combining the
Best of Electric &
Hydraulic Systems*

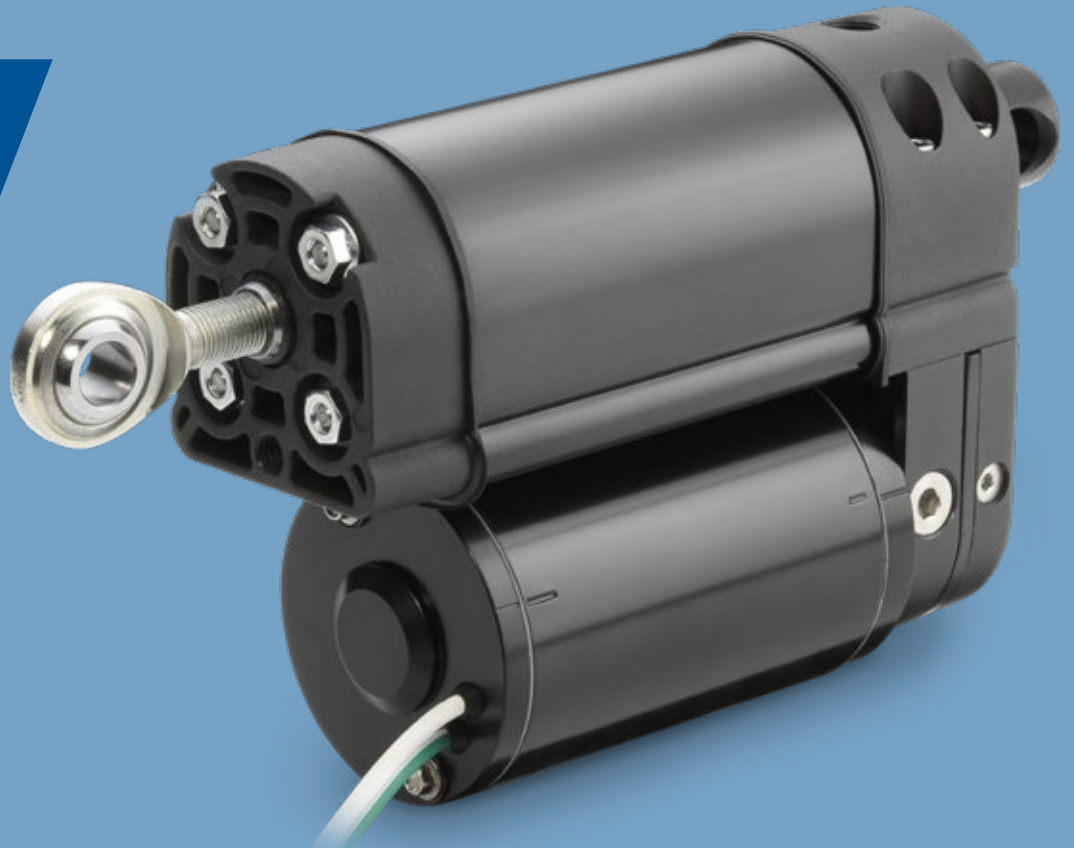

H-Track

Electro-Hydraulic Linear Actuator

Featuring Power Density and Shock Load Resistance



H-Track – A Compact Hybrid of Superior Performance

H-Track electro-hydraulic actuators provide the high-load performance of hydraulics without the expansive space requirements nor the prohibitive cost of full-sized, fluid-based systems.

More Power in Less Space

H-Track electro-hydraulic actuators feature the smallest mounting envelope in their class with a patented valve and reservoir design that provides significant space savings compared to competitive models. H-Track is a robust linear actuator providing force up to 4800 lbf (21350 N) and travel speeds near 4 in (100 mm) per second. With stroke lengths up to 16 in (406 mm), end switch options and multiple configurations available, the H-Track offers a unique set of options for machine designers.

Made for Tough Conditions

H-Track actuators are weatherproof, dust tight, corrosion resistant, and IP67 static (temporary submersion) and IP69K (high-pressure washdown) tested. The H-Track offers an optional operation temperature as low as -40°F (-40°C) to as high as 180°F (82°C), making it an ideal option for use in demanding conditions.





Completely Self-Contained

The motor, pump and valves are contained in one mini power pack mounted directly to the combined cylinder/fluid tank. This means that the inner workings are completely sealed from the outside, allowing this unique arrangement to minimize parts and improve performance. Unlike hydraulic cylinders, there is no need for external hoses, valves, reservoirs or hydraulic connectors that can break or leak. The operation is as simple as with a traditional electric actuator - just turn the supply voltage on to move and change polarity to reverse direction. If necessary, the actuator extension tube can be manually overridden, allowing the tube to float for operating in emergency situations.

THE BEST OF TWO WORLDS

ELECTRICALLY POWERED AND CONTROLLED

- **SIMPLE TO CONTROL**
- **NO NEED FOR BULKY EXTERNAL HOSES, VALVES OR PUMPS**
- **MINIMAL RISK OF LEAKAGE**
- **MAINTENANCE FREE**

HYDRAULIC MOTION

- **HIGH POWER DENSITY**
- **HIGH SHOCK LOAD AND VIBRATION RESISTANCE**
- **SMOOTH MOTION**
- **QUIET OPERATION**



Electro-Hydraulic Advantages

The best features from the electric and hydraulic actuator worlds have been chosen to power the H-Track linear actuator, giving it a unique set of capabilities that allow it to be used in applications that otherwise might be too difficult for other solutions to take on.

Compact Design

H-Track actuators have a mounting length that is shorter than any other electromechanical actuator on the market. It can fit into applications with a pin-to-pin length as small as 4.8 in (122 mm) plus its stroke, and still provide up to 4800 lbf (21350 N) of force.

Superb Load Holding Power

H-Track actuators operate in both tension and compression and will hold a load stationary without power in either direction. Static load holding capability will always exceed the dynamic load moving capability.

Vibration and Shock Load Resistant

H-Track actuators are immune to vibrational drifting, hydraulically self lock and safely absorb shocks.

Energy Efficient

Electric control provides clean, smooth linear motion without hydraulic plumbing or other expensive componentry. The H-Track's power demands are significantly less than those of a full hydraulic system as the actuators require power only when in motion.

Solid Extension Tube

Since the extension tube is solid, it allows for increased resistance to buckling compared to a hollow extension tube of the same size.



Hydraulics Isolated from the Atmosphere

The fluid reservoir is vented and isolated from the atmosphere with a flexible lid, allowing actuator and pump operation in any orientation without entraining or cavitation.

Maintenance-Free

H-Track actuators require no lubrication, hydraulic fluid fillup, or any other type of maintenance or adjustments for their entire lifecycle.

Contamination-Free

The H-Track pump is burnished, cleaned, flushed and vacuum filled with degassed hydraulic fluid. The system is completely sealed with no hoses to leak. This ensures you enjoy contaminant-free performance for the life of the actuator.

Thoroughly Tested

Throughout their entire development process, H-Track actuators are rigorously tested to ensure they meet all relevant standards and performance specifications prior to leaving the factory. Please contact Thomson customer support to learn more about which standards H-Track meets and how our testing is carried out.

Customization

As with most Thomson products, H-Track actuators can be customized. Our engineers will work with you to determine the modifications needed – from a simple color change to a complete overhaul of the design. Thomson is a global leader in custom actuator production and takes pride in supplying the optimal solution to each customer.





Built to Perform

H-Track is built from the outside in to excel in situations where many other actuators are forced to bow out. The unique electro-hydraulic design combines the best features from two distinct systems and opens up new application possibilities for linear actuators.

MORE POWER IN LESS SPACE

H-Track is one of the strongest actuators for its size without compromising life expectancy or the ability to withstand the elements.

- 1 **Compact and strong power pack unit, containing pump, valve and motor**
- 2 **Fluid tank integrated into the cover tube**
- 3 **Solid small-diameter, buckling-resistant extension tube**



COMPLETELY SELF CONTAINED

Get the best from the electric and hydraulic worlds in one package. H-Track is powerful, tough, and vibration and shock load resistant. Yet it only needs a battery and a switch to run, requires no maintenance, and minimizes the risks and hazards associated with hydraulic fluid leaks.

- 4 **Power pack unit completely sealed from the outside**
- 5 **Two-wire operation**
- 6 **Large number of power pack and cylinder configurations allow for great design flexibility**

MADE FOR TOUGH CONDITIONS

H-Track is designed and tested to operate under the harshest conditions without failure or the need for maintenance.

7 IP69K/IP67 protection class

8 Chrome finished steel extension tube

9 Salt spray tested for 200 hours

10 Large operating temperature range

11 High shock load and vibration resistance

12 Anodized aluminum alloy housing





Built for the Toughest Applications

With a self-contained electro-hydraulic system, H-Track actuators meet the growing demand for power-dense performance used in a variety of industrial applications, including agricultural sprayer booms, snow plow blades and mower deck lifts.

Designed to Withstand Life on the Fields

With agricultural sprayers becoming larger and boom lengths reaching up to 177 ft (54 m), strain on the actuators has increased exponentially. Actuators are used to fold the long sprayer booms from an extended position to a stowed position for transport. The folding and unfolding of these booms apply

very high loads on the actuators. The strain on the units is dramatically increased when the sprayer is in motion and the bouncing of the booms causes even more extreme loads. These combined loads create tremendous impact force that can easily destroy most other electric actuators. The H-Track is designed to handle this type of loading with ease.

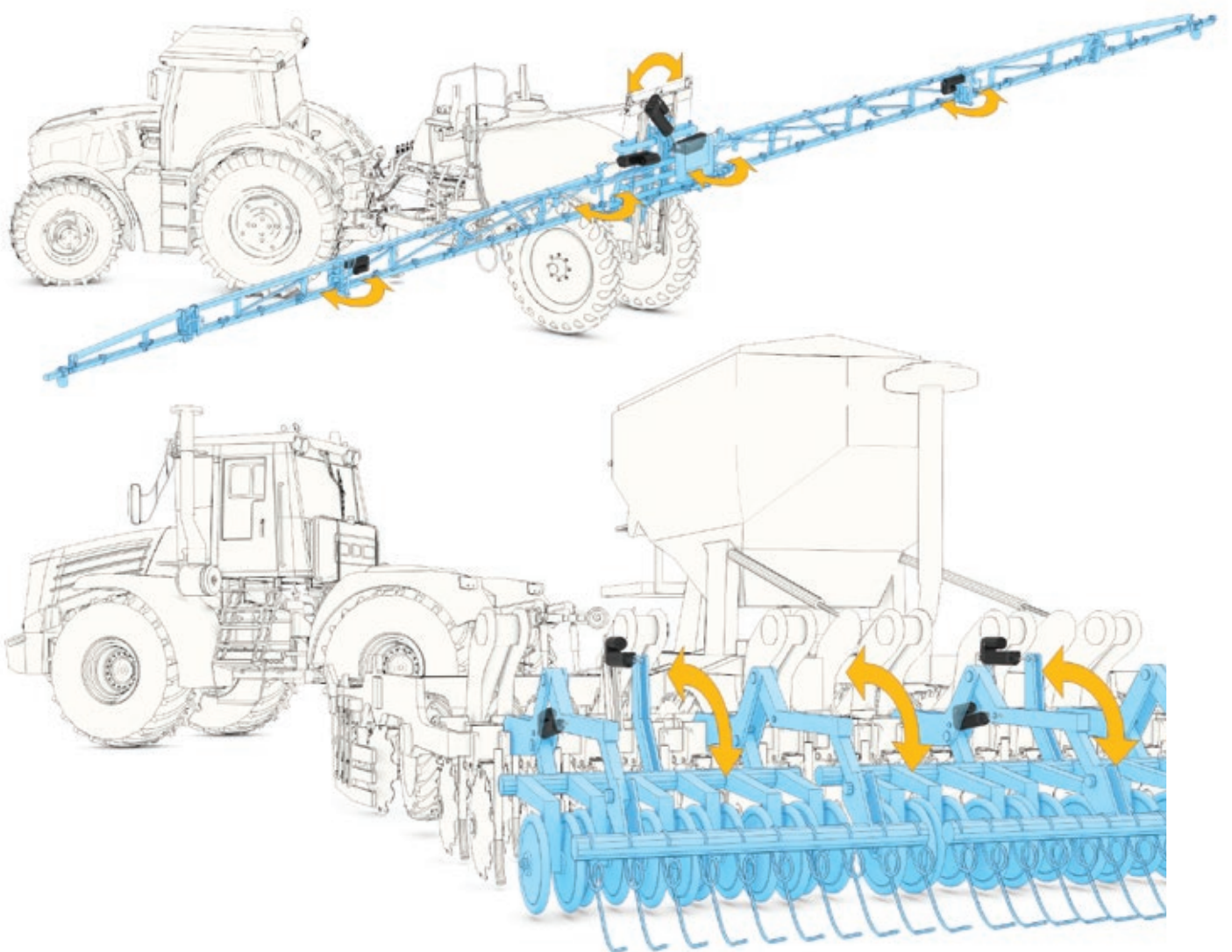

Ideal for Demanding Outdoor Applications

Where the often harsh outdoor environment creates conditions that can be fatal for most actuators, the H-Track thrives. A snow plow battling icy roads and striking a stationary, concrete object is an example that would quickly destroy most linear actuators. The H-Track's unique valve and reservoir design gives it the ability to cushion these blows and continue operating without issue. The optional ability to operate in temperatures as

low as -40°F (-40°C) makes it a perfect fit for even the coldest climates. Mower deck lifts are typically where electric actuators shine, but with increasing deck sizes and ground speeds, the limits of these traditional actuators are being exceeded. With its reliable, load-holding capabilities, enhanced durability for higher transport speeds, and ability to withstand high-pressure washdowns, the H-Track is a perfect choice for the next generation of larger, faster mowers.

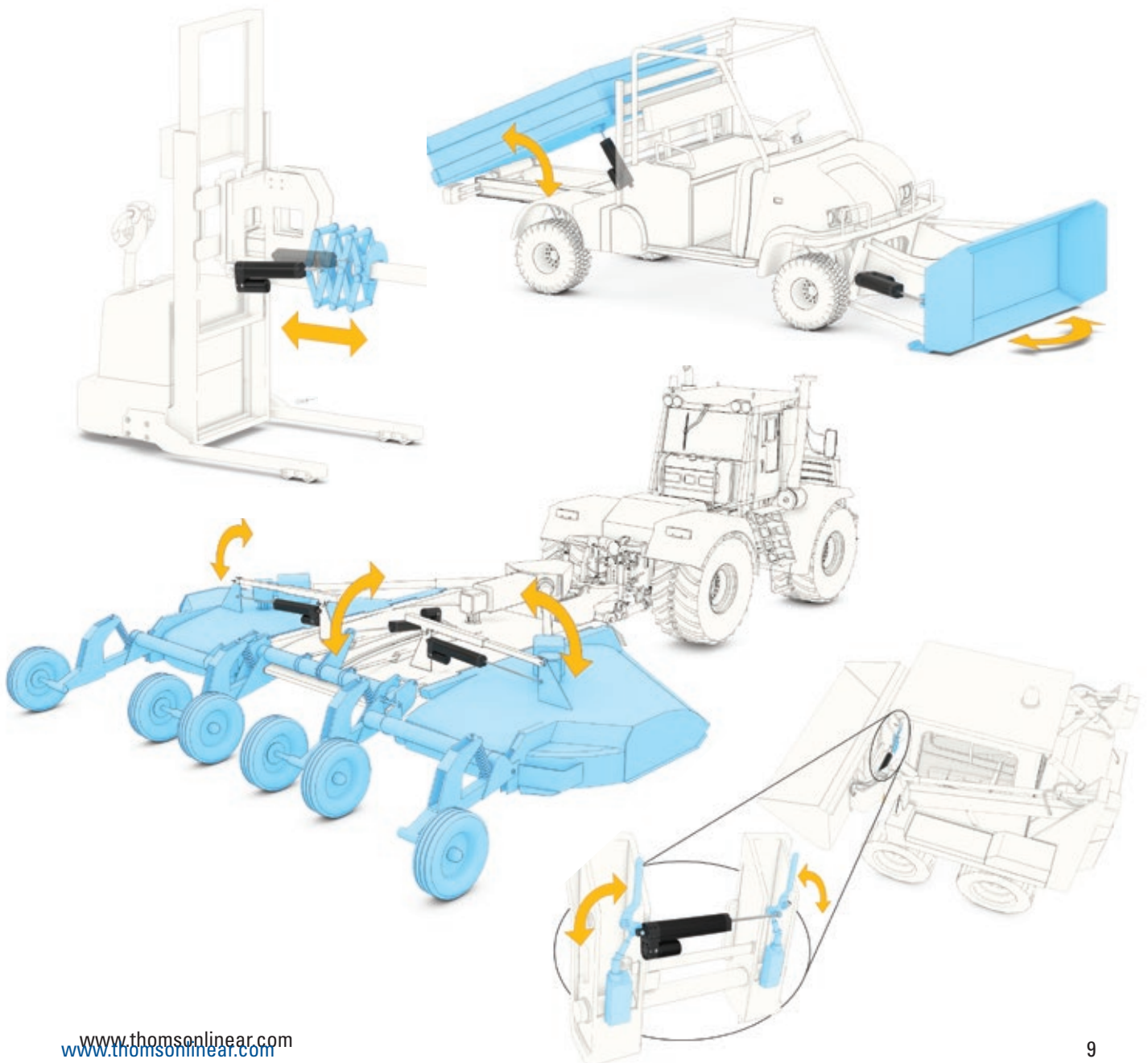



Technical Features



H-Track Electro-Hydraulic Linear Actuator

- Combines the best from the hydraulic and electric worlds.
- High power density.
- Very compact and short pin-to-pin versus stroke length relationship.
- Solid extension tube allows for increased resistance to buckling.
- Immune to vibrational drifting and hydraulically self locks.
- High shock load and vibration resistance.
- Fluid reservoir is vented and isolated from the atmosphere with a flexible lid, allowing actuator and pump operation in any orientation without entraining or cavitation.
- Standard strokes up to 16 in (406 mm).
- Designed for harsh outdoor conditions.
- Reliable and maintenance free.

General Specifications

Cylinder type	hydraulic
Pump type	internal electric gear pump
Manual override	yes
Anti-rotation	no
Motor protection	built-in auto reset thermal switch
Static load holding brake	no (self-locking)
Pressure relief valve	yes (for both directions)
Electrical connections	flying leads + Packard 56 male connector flying leads + ring terminals
240 W motor	
560 W motor	
Compliance	CE, RoHs, REACH, Prop65

Optional Features

Mechanical options	Alternative front adapter ends
	Alternative rear adapter orientation

Technical Specifications

Mechanical Specifications		
Max. static compression load (Fx)	[lbf (N)]	5000 (22241)
Max. dynamic load (Fx)	[lbf (N)]	see page 21
Speed retract @ no load/max. load	[in/s (mm/s)]	see page 21
Speed extend @ no load/max. load	[in/s (mm/s)]	see page 21
Min. ordering stroke (S) length	[in]	2
Max. ordering stroke (S) length	[in]	16
Ordering stroke length increments	[in]	2
Operating temperature limits*	[F (°C)]	-20 – 150 (-26 – 65)
Full load duty cycle @ 25 °C (77 °F)	[%]	25
End play, maximum	[in (mm)]	0.015 (0.4)
Restraining torque	[lb-in (Nm)]	0.89 (0.1)
Protection class - static		IP67/IP69K
Protection class - dynamic		IP65
Salt spray resistance	[h]	200
Weight	[lb (kg)]	see page 13

* Other limits possible, contact Thomson customer support for information.

Electrical Specifications		
Available input voltages	[Vdc]	12, 24, 48
Input voltage tolerance	[Vdc]	
12 Vdc models		9 – 16
24 Vdc models		18 – 32
48 Vdc models		36 – 64
Current draw @ no load/max. load	[A]	see page 21
Motor leads cross section	[AWG (mm ²)]	
240 W motor models		14 (2)
560 W motor models		12 (3)
Motor ring terminals cross section	[AWG (mm ²)]	
240 W motor models		-
560 W motor models		10
Motor lead length, standard	[in (mm)]	10 (254)

Electrical Connections

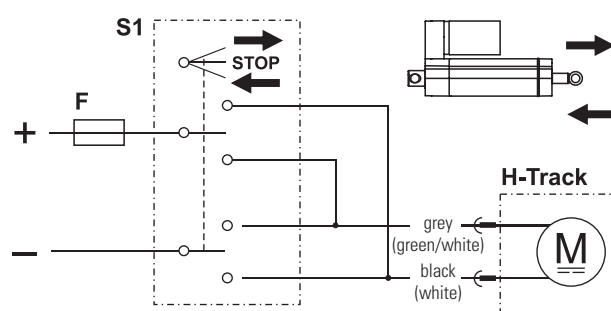

F Fuse
S1 Double pole double throw switch

To extend the actuator, apply +Vdc to black (white) and -Vdc to grey (green/white). To retract, apply -Vdc to black (white) and +Vdc to grey (green/white). Colors in between brackets are valid for the 560 W motor. Avoid running the actuator in to the ends.



Dimensions

Dimensions	Projection
inch [mm]	

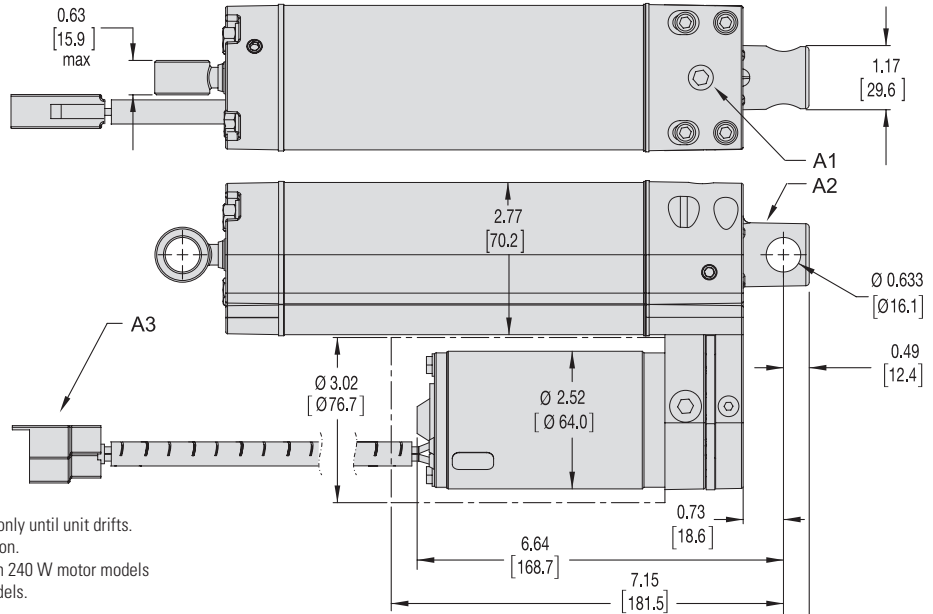
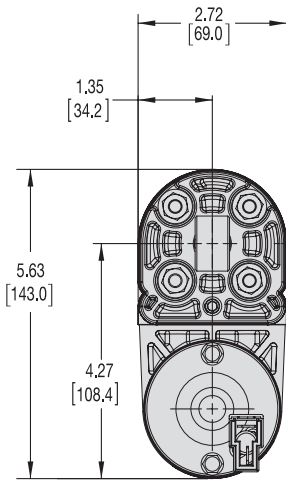

A1: Manual release. Do not remove. Rotate CCW only until unit drifts.
 A2: Rear adapter hole shown in standard orientation.
 A3: Flying leads and male Packard 56 connector on 240 W motor models and ¼ inch ring terminals on 560 W motor models.

Type A front adapter

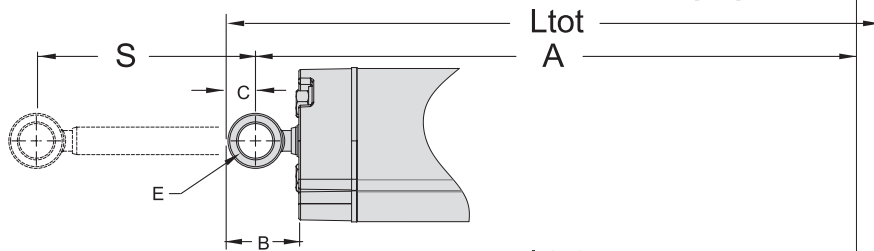

Type B front adapters

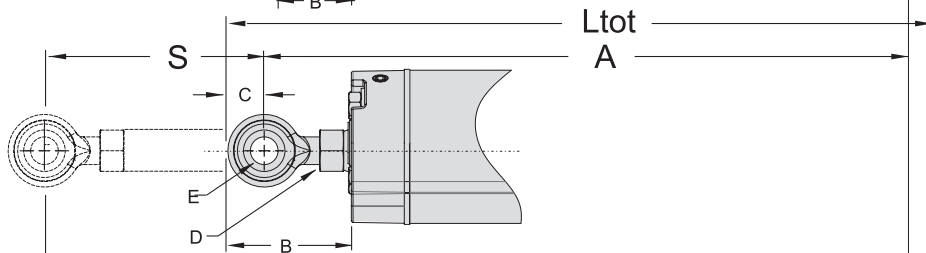

Type C front adapters

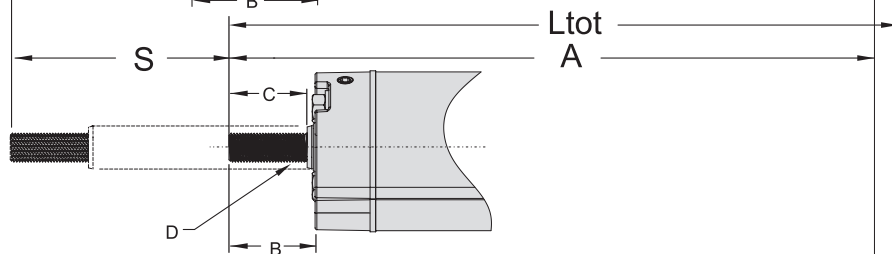

Type D front adapters

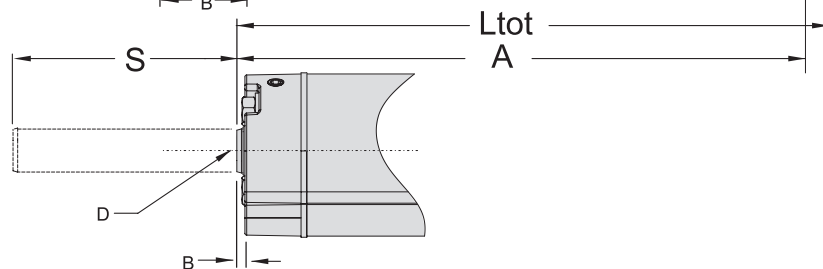

Dimensions

Dimensions				
Front Adapter	Type A	Type B	Type C	Type D
Standard Ordering Strokes (S) [in]	2, 4, 6, 8, 10, 12, 14, 16			
Total Length (Ltot) [in]	$L_{tot} = A + C + 0.49$	$L_{tot} = A + C + 0.49$	$L_{tot} = A + 0.49$	$L_{tot} = A + 0.49$
Retracted Length (A) [in]				
Bore Size H1	$A = S + 4.8$	$A = S + 5.5$	$A = S + 5.1$	$A = S + 4.2$
Bore Size H2	$A = S + 4.8$	$A = S + 5.4$	$A = S + 5.2$	$A = S + 4.2$
Bore Size H3	$A = S + 4.8$	$A = S + 5.7$	$A = S + 5.5$	$A = S + 4.2$
Dimension B [in]				
Bore Size H1	1.31	1.58	1.13	0.14
Bore Size H2	1.31	1.66	1.31	0.14
Bore Size H3	1.31	1.89	1.50	0.14
Dimension C [in]				
Bore Size H1	0.52	0.50	0.99	-
Bore Size H2	0.52	0.56	1.17	-
Bore Size H3	0.52	0.66	1.36	-
Dimension D [in]				
Bore Size H1	-	3/8-24 THREADS	3/8-24 THREADS	3/8-24 THREADS x 0.88
Bore Size H2	-	7/16-20 THREADS	7/16-20 THREADS	7/16-20 THREADS x 0.88
Bore Size H3	-	1/2-20 THREADS	1/2-20 THREADS	1/2-20 THREADS x 0.88
Dimension E [in]				
Bore Size H1	Ø 0.631	Ø 0.38THRU	-	-
Bore Size H2	Ø 0.631	Ø 0.44 THRU	-	-
Bore Size H3	Ø 0.631	Ø 0.50 THRU	-	-

Weight

Actuator Weight [lb (kg)]								
Actuator Type	Ordering Stroke (S) [in]							
	2	4	6	8	10	12	14	16
H1x-xx-1	6.4 (2.9)	7.2 (3.3)	8.0 (3.6)	8.8 (4.0)	9.6 (4.4)	10.4 (4.7)	11.2 (5.1)	12.0 (5.4)
H2x-xx-1	6.9 (3.1)	7.8 (3.5)	8.7 (3.9)	9.6 (4.4)	10.5 (4.8)	11.4 (5.2)	12.3 (5.6)	13.2 (6.0)
H3x-xx-1	7.1 (3.2)	8.2 (3.7)	9.3 (4.2)	10.4 (4.7)	11.5 (5.2)	12.6 (5.7)	13.7 (6.2)	14.8 (6.7)
H1x-xx-2	8.0 (3.6)	8.8 (4.0)	9.6 (4.4)	10.4 (4.7)	11.2 (5.1)	12.0 (5.4)	12.8 (5.8)	13.6 (6.2)
H2x-xx-2	8.5 (3.9)	9.4 (4.3)	10.3 (4.7)	11.2 (5.1)	12.1 (5.5)	13.0 (5.9)	13.9 (6.3)	14.8 (6.7)
H3x-xx-2	8.7 (3.9)	9.8 (4.4)	10.9 (4.9)	12.0 (5.4)	13.1 (5.9)	14.2 (6.4)	15.3 (6.9)	16.4 (7.4)



Performance Matrix

Performance Matrix*													
Load Configuration (see page 18)	Model	Max. Dynamic Load [lbf (N)]		Current Draw [A]						Extend Speed [in/s (mm/s)]		Retract Speed [in/s (mm/s)]	
		Extending	Retracting	@ Max. Load			@ No Load			@ Max. Load	@ No Load	@ Max. Load	@ No Load
				12 Vdc	24 Vdc	48 Vdc	12 Vdc	24 Vdc	48 Vdc				
C	H1C-xx-1B11	1000 (4448)	750 (3336)	8	4	3	18	13	5	0.50 (12.7)	1.75 (44.5)	2.19 (55.6)	0.63 (16.0)
	H1C-xx-1B41	500 (2224)	375 (1668)	8	4	3	18	13	5	1.00 (25.4)	3.50 (88.9)	4.38 (111.3)	1.25 (31.8)
	H1C-xx-2B11	1500 (6672)	1125 (5004)	18	9	5	38	26	13	0.50 (12.7)	1.75 (44.5)	2.19 (55.6)	0.63 (16.0)
	H1C-xx-2B41	750 (3336)	563 (2504)	18	9	5	38	26	13	1.00 (25.4)	3.50 (88.9)	4.38 (111.3)	1.25 (31.8)
	H2C-xx-1A12	2400 (10676)	1750 (7784)	8	4	3	18	13	5	0.15 (3.8)	0.50 (12.7)	0.60 (15.2)	0.18 (4.6)
	H2C-xx-1B32	1250 (5560)	992 (4413)	8	4	3	18	13	5	0.40 (10.2)	1.40 (35.6)	1.69 (42.9)	0.48 (12.2)
	H2C-xx-2A22	3000 (13345)	2380 (10587)	18	9	5	38	26	13	0.19 (4.8)	0.65 (16.5)	0.78 (19.8)	0.23 (5.8)
	H2C-xx-2B32	1875 (8340)	1488 (6619)	18	9	5	38	26	13	0.40 (10.2)	1.40 (35.6)	1.69 (42.9)	0.48 (12.2)
	H3C-xx-1A13	3200 (14234)	2400 (10676)	8	4	3	18	13	5	0.13 (3.3)	0.45 (11.4)	0.56 (14.2)	0.16 (4.1)
	H3C-xx-1B23	1750 (7784)	1313 (5841)	8	4	3	18	13	5	0.29 (7.4)	1.00 (25.4)	1.25 (31.8)	0.36 (9.1)
	H3C-xx-2A13	4800 (21351)	3600 (16014)	18	9	5	38	26	13	0.13 (3.3)	0.45 (11.4)	0.56 (14.2)	0.16 (4.1)
	H3C-xx-2B23	2625 (11677)	1969 (8759)	18	9	5	38	26	13	0.29 (7.4)	1.00 (25.4)	1.25 (31.8)	0.36 (9.1)
H	H1H-xx-1B11	1000 (4448)	750 (3336)	8	4	3	18	13	5	1.75 (44.4)	0.50 (12.7)	0.63 (16.0)	2.19 (55.6)
	H1H-xx-1B41	500 (2224)	375 (1668)	8	4	3	18	13	5	3.50 (88.9)	1.00 (25.4)	1.25 (31.8)	4.38 (111.3)
	H1H-xx-2B11	1500 (6672)	1125 (5004)	18	9	13	38	26	22	1.75 (44.4)	0.50 (12.7)	0.63 (16.0)	2.19 (55.6)
	H1H-xx-2B41	750 (3336)	563 (2504)	18	9	13	38	26	22	3.50 (88.9)	1.00 (25.4)	1.25 (31.8)	4.38 (111.3)
	H2H-xx-1A12	2400 (10676)	1750 (7784)	8	4	3	18	13	5	0.50 (12.7)	0.15 (3.8)	0.18 (4.6)	0.60 (15.2)
	H2H-xx-1B32	1250 (5560)	992 (4413)	8	4	3	18	13	5	1.40 (35.6)	0.40 (10.2)	0.48 (12.2)	1.69 (42.9)
	H2H-xx-2A22	3000 (13345)	2380 (10587)	18	9	13	38	26	22	0.65 (16.5)	0.19 (4.8)	0.23 (5.8)	0.78 (19.8)
	H2H-xx-2B32	1875 (8340)	1488 (6619)	18	9	13	38	26	22	1.40 (35.6)	0.40 (10.2)	0.48 (12.2)	1.69 (42.9)
	H3H-xx-1A13	3200 (14234)	2400 (10676)	8	4	3	18	13	5	0.45 (11.4)	0.13 (3.3)	0.16 (4.1)	0.56 (14.2)
	H3H-xx-1B23	1750 (7784)	1313 (5841)	8	4	3	18	13	5	1.00 (25.4)	0.29 (7.4)	0.36 (9.1)	1.25 (31.8)
	H3H-xx-2A13	4800 (21351)	3600 (16014)	18	9	13	38	26	22	0.45 (11.4)	0.13 (3.3)	0.16 (4.1)	0.56 (14.2)
	H3H-xx-2B23	2625 (11677)	1969 (8759)	18	9	13	38	26	22	1.00 (25.4)	0.29 (7.4)	0.36 (9.1)	1.25 (31.8)
N	H1N-xx-1B11	1000 (4448)	750 (3336)	42	21	10.5	8	5	2.5	0.50 (12.7)	1.75 (44.4)	0.63 (16.0)	2.19 (55.6)
	H1N-xx-1B41	500 (2224)	375 (1668)	42	21	10.5	8	5	2.5	1.00 (25.4)	3.50 (88.9)	1.25 (31.8)	4.38 (111.3)
	H1N-xx-2B11	1500 (6672)	1125 (5004)	80	43	22	14	10	7	0.50 (12.7)	1.75 (44.4)	0.63 (16.0)	2.19 (55.6)
	H1N-xx-2B41	750 (3336)	563 (2504)	80	43	22	14	10	7	1.00 (25.4)	3.50 (88.9)	1.25 (31.8)	4.38 (111.3)
	H2N-xx-1A12	2400 (10676)	1750 (7784)	42	21	10.5	8	5	2.5	0.15 (3.8)	0.50 (12.7)	0.18 (4.6)	0.60 (15.2)
	H2N-xx-1B32	1250 (5560)	992 (4413)	42	21	10.5	8	5	2.5	0.40 (10.2)	1.40 (35.6)	0.48 (12.2)	1.69 (42.9)
	H2N-xx-2A22	3000 (13345)	2380 (10587)	80	43	22	14	10	7	0.19 (4.8)	0.65 (16.5)	0.23 (5.8)	0.78 (19.8)
	H2N-xx-2B32	1875 (8340)	1488 (6619)	80	43	22	14	10	7	0.40 (10.2)	1.40 (35.6)	0.48 (12.2)	1.69 (42.9)
	H3N-xx-1A13	3200 (14234)	2400 (10676)	42	21	10.5	8	5	2.5	0.13 (3.3)	0.45 (11.4)	0.16 (4.1)	0.56 (14.2)
	H3N-xx-1B23	1750 (7784)	1313 (5841)	42	21	10.5	8	5	2.5	0.29 (7.4)	1.00 (25.4)	0.36 (9.1)	1.25 (31.8)
	H3N-xx-2A13	4800 (21351)	3600 (16014)	80	43	22	14	10	7	0.13 (3.3)	0.45 (11.4)	0.16 (4.1)	0.56 (14.2)
	H3N-xx-2B23	2625 (11677)	1969 (8759)	80	43	22	14	10	7	0.29 (7.4)	1.00 (25.4)	0.36 (9.1)	1.25 (31.8)

* The table above is valid for the temperature span of 40 – 120°F (4 – 50°C). H-Track can operate in the larger range of -20 – 150°F (-26 – 65°C), but at temperatures below 40°F (4°C), force and current begin to increase, while speed decreases. At temperatures above 120°F (50°C), speed will decrease slightly. The exact amount of performance change is difficult to calculate. Also, when it comes to the lower temperature span, the performance will move towards what is stated above as the temperature rises in the actuator due to the heat generated by its work. Please consult Thomson customer service for more information.

Ordering Key

Ordering Key								
1	2	3	4	5	6	7	8	9
H1	C-	12-	1	A2	2	-A	06	
<p>1. Bore size ⁽¹⁾ H1 = 1.000 in H2 = 1.375 in H3 = 1.500 in</p> <p>2. Load configuration ⁽¹⁾ C- = gravity push on the load/extension tube when extending H- = gravity pull on the load/extension tube when extending B- = gravity both push and pull on the load/extension tube in both directions ⁽²⁾ N- = gravity does not affect the load/extension tube in any direction</p> <p>3. Input voltage ⁽¹⁾ 12- = 12 Vdc 24- = 24 Vdc 48- = 48 Vdc</p> <p>4. Motor power ⁽¹⁾ 1 = 240 W 2 = 560 W</p> <p>5. Pump size ⁽¹⁾ A1 = gear tooth 16, thickness 0.125 in A2 = gear tooth 16, thickness 0.156 in A3 = gear tooth 16, thickness 0.188 in A4 = gear tooth 16, thickness 0.250 in B1 = gear tooth 12, thickness 0.125 in B2 = gear tooth 12, thickness 0.156 in B3 = gear tooth 12, thickness 0.188 in B4 = gear tooth 12, thickness 0.250 in</p>					<p>6. Extension tube diameter 1 = 0.500 in (always with bore size H1) 2 = 0.625 in (always with bore size H2) 3 = 0.750 in (always with bore size H3)</p> <p>7. Extension tube front adapter -A = Standard -B = Spherical -C = Male Thread -D = Female Thread</p> <p>8. Stroke length ⁽³⁾ 02 = 2 in (50 mm) 04 = 4 in (100 mm) 06 = 6 in (150 mm) 08 = 8 in (200 mm) 10 = 10 in (254 mm) 12 = 12 in (300 mm) 14 = 14 in (356 mm) 16 = 16 in (406 mm)</p> <p>9. Rear adapter orientation blank = standard R90 = 90° position</p> <p>(1) See page 14 for sizing and selection guidelines. (2) Contact customer support before choosing configuration B. (3) Other stroke lengths available upon request. Please contact customer support.</p>			



Sizing and Selection

In order to choose the optimal H-Track actuator for your application, please follow the sizing and selection process as described below. Do not hesitate to contact Thomson customer support if you need assistance.

Step 1. Determining Load Configuration

Determine which load configuration (C, H, N or B) is valid for your application. Also see page 18.

Example: Assuming that the load needs to be pushed horizontally, and the extension tube will not be affected by gravity when pushing or pulling, then the application corresponds to load configuration N.

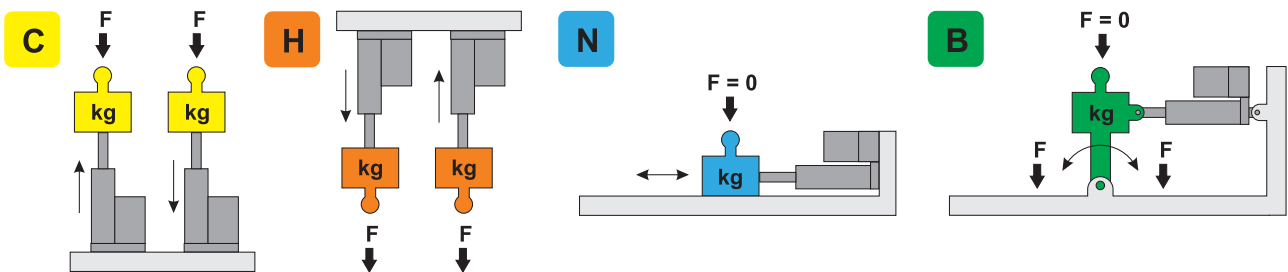

Step 2. Bore and Extension Tube Sizing

Determine which bore size is needed for your load and stroke. Also see page 19.

Example: Assuming the application requires 16-in stroke, and that load is 2500 lbf at extension (red dot) and 500 lbf at retraction (yellow dot), then the Stroke vs. Load and Bore Size diagram below shows, that only the blue curve is above both points. Therefore, bore size H3 is the only possible choice in this case.

Stroke vs. Load and Bore Size

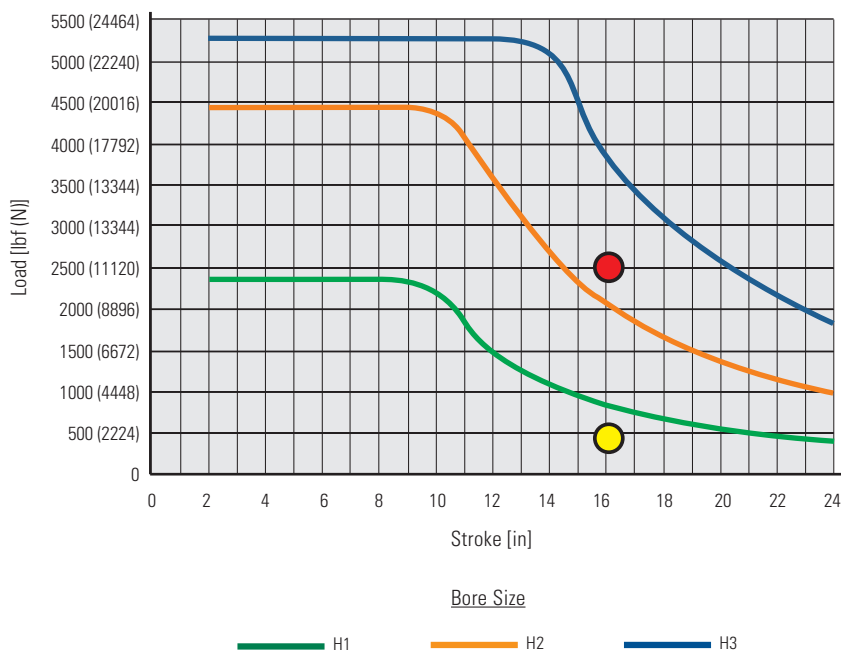

Step 3. Sizing of Motor, Pump and Power Supply

Determine the size of the actuator motor and pump for your application, as well as the current draw by referring to the diagrams on pages 20 - 22.

Example: Since the load configuration in step 1 was determined to be of type N, refer to the diagrams on page 22.

In the Load vs. Speed diagrams for load configuration N, the maximum extension and retraction loads that were assumed in step 2 are shown by the vertical lines. In this example, we also assume that a travel speed of 0.25 in/s is required when extending and 1 in/s when retracting. The only H3 bore size of the four that can deliver that speed when extending at 2500 lbf and retracting at 500 lbf is model H3N-xx-2B23.

In order to size the power supply, you must decide which voltage to use and the maximum load current draw at extension and retraction. To do that, first determine the percentage of the maximum permissible load that is used in each direction.

According to the Load vs. Speed diagram, H3N-xx-2B23 has a maximum load of about 2700 lbf at extension and 2000 lbf at retraction (the exact max. load values can be found in the Performance Matrix on page 14). The assumed maximum loads needed in the application, which requires 2500 lbf at extension and 500 lbf at retraction, are about 92% (red line) and 25% (yellow line) of the maximum permissible loads. The current for H3N-xx-2B23 equipped with a 24 Vdc motor (model H3N-24-2B2) would, in this case, follow the dotted red line and be about 20 A at extension and 40 A at retraction. Be sure to size your power supply with some margin.

Step 4. Finishing the Ordering Code

At this point, the ordering code is H3N-24-2B23-xxxx. In order to complete it, the type of extension tube front adapter, the stroke length and the rear adapter orientation need to be determined. Also see page 15.

Example: In step 2, it was assumed the application required a 16-in stroke, which means the code becomes H3N-24-2B23-x16x. If we assume a standard front adapter and a 90° rear adapter orientation are required, the complete ordering code would be H3N-24-2B23-A16R.

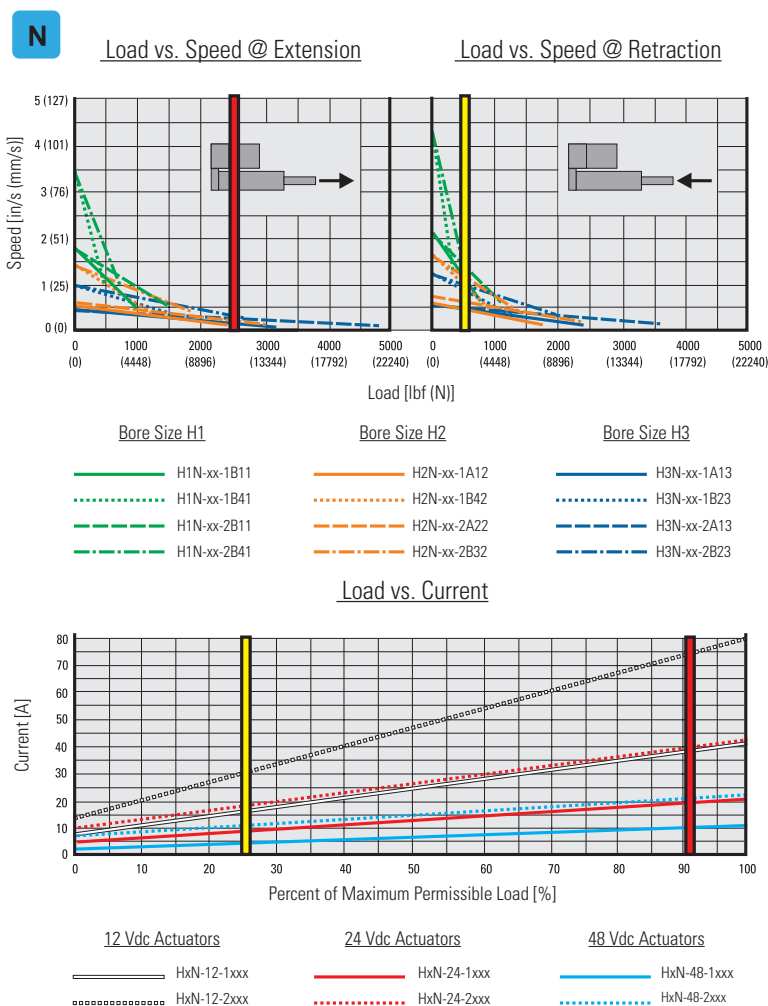

Determining Load Configuration

There are four main types of load and gravity configurations, which will determine the performance of the actuator. Please refer to the configurations below and choose the one that best corresponds to your application. Contact Thomson customer support if you are unable to determine a valid configuration for your application.

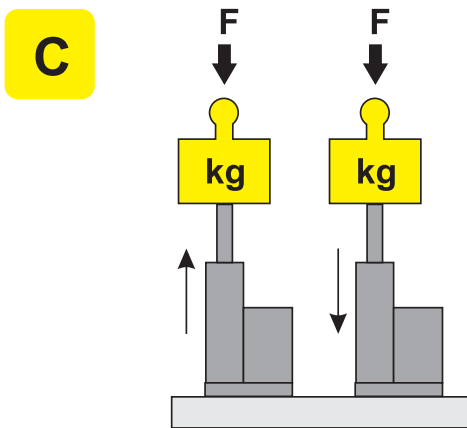

Configuration C

The gravity resists the load being moved when the actuator extends and helps it when retracting.

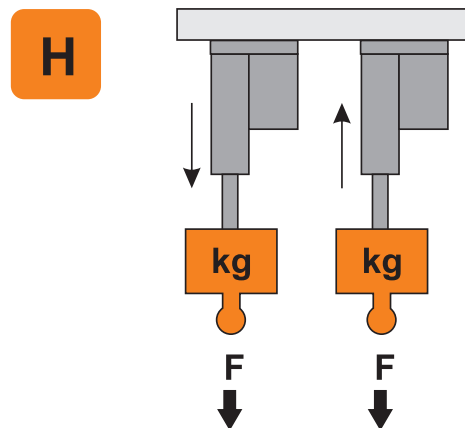

Configuration H

The gravity helps the load being moved when the actuator extends and resists it when retracting.

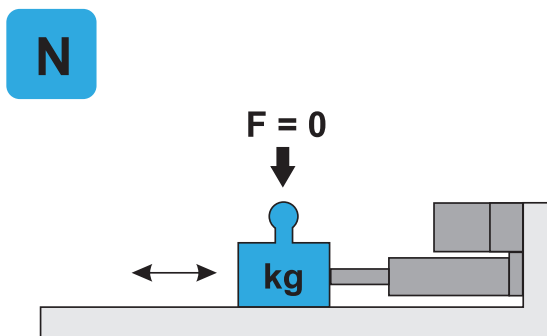

Configuration N

The gravity does not affect the load in any direction.

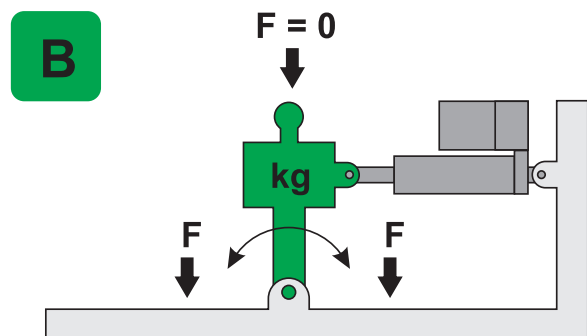

Configuration B

The gravity both helps and resists the load being moved in both directions except at one point where the load is not affected by the gravity at all. If this is your configuration, try to re-design the mechanical linkage so that the result is a C, H or N configuration. Please contact Thomson customer support if that is not possible.

Sizing of Bore and Extension Tube

The maximum load in each direction and the required stroke length determine the minimum bore and extension tube size needed for the actuator. Refer to the diagram below to determine which bore size your application requires. If no solution exists, the stroke and/or load must be reduced. Contact Thomson customer support if you are unable to determine a valid combination for your application.

Stroke vs. Load and Bore Size

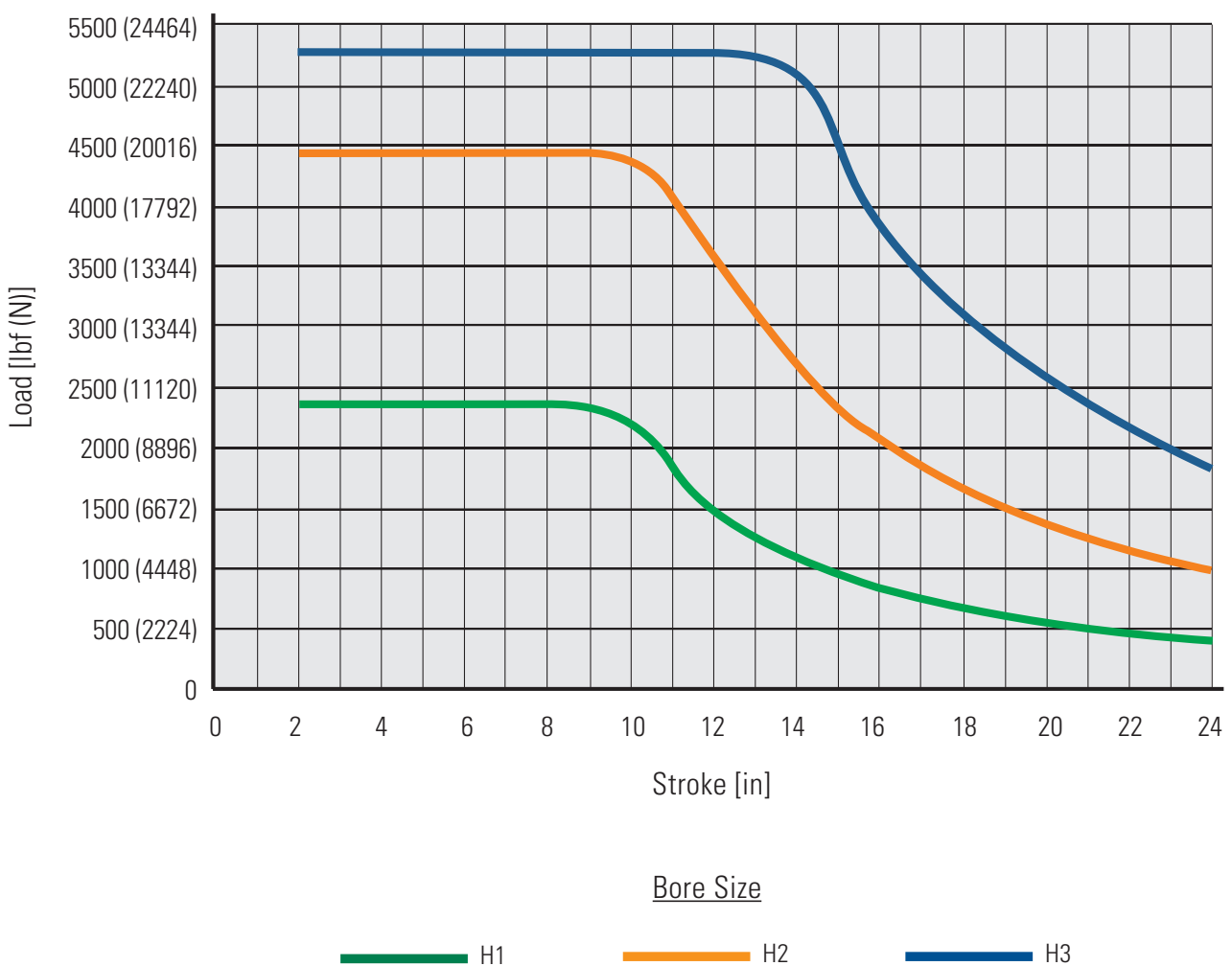



Sizing of Motor, Pump and Power Supply

C

Load vs. Speed @ Extension

Load vs. Speed @ Retraction

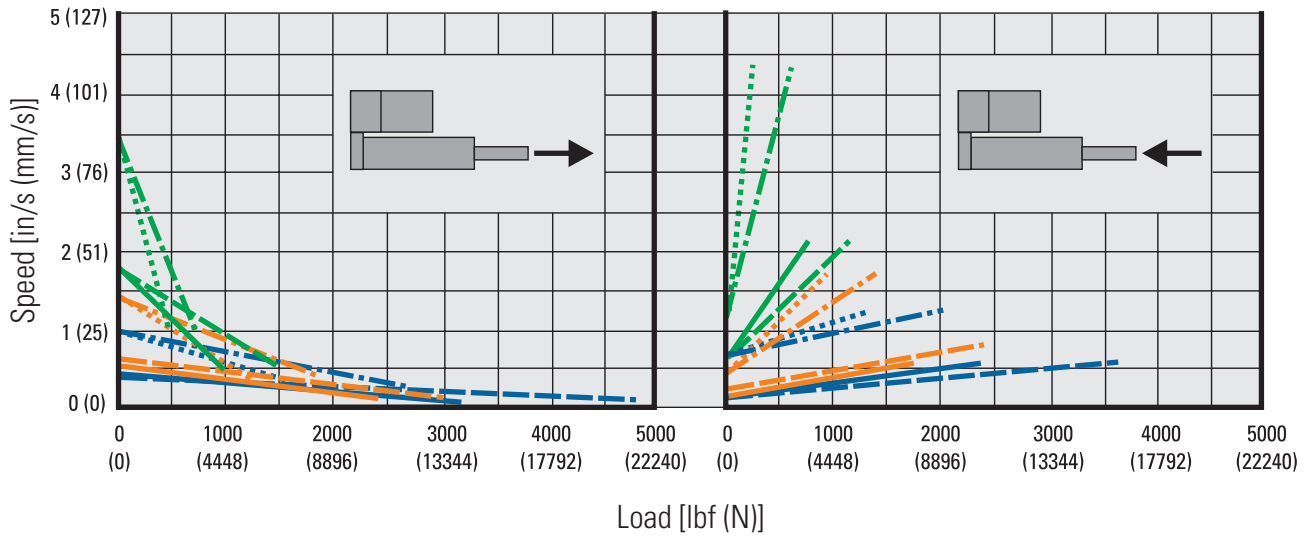

Bore Size H1

Bore Size H2

Bore Size H3

- H1C-xx-1B11
- ⋯ H1C-xx-1B41
- - - H1C-xx-2B11
- · - · H1C-xx-2B41

- H2C-xx-1A12
- ⋯ H2C-xx-1B32
- - - H2C-xx-2A22
- · - · H2C-xx-2B32

- H3C-xx-1A13
- ⋯ H3C-xx-1B23
- - - H3C-xx-2A13
- · - · H3C-xx-2B23

Load vs. Current

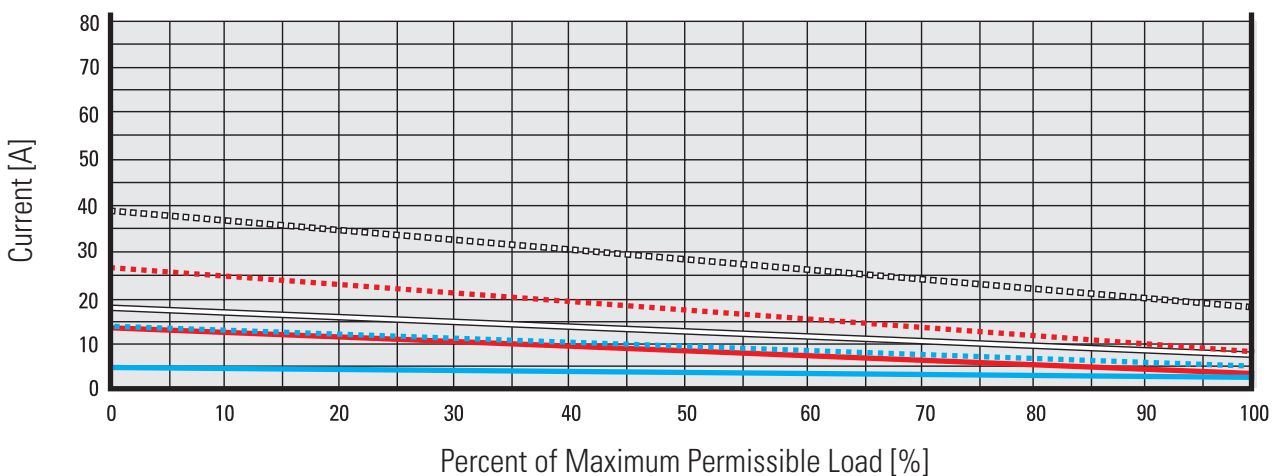

12 Vdc Actuators

24 Vdc Actuators

48 Vdc Actuators

- HxC-12-1xxx
- ⋯ HxC-12-2xxx

- HxC-24-1xxx
- ⋯ HxC-24-2xxx

- HxC-48-1xxx
- ⋯ HxC-48-2xxx

Sizing of Motor, Pump and Power Supply



Load vs. Speed @ Extension

Load vs. Speed @ Retraction

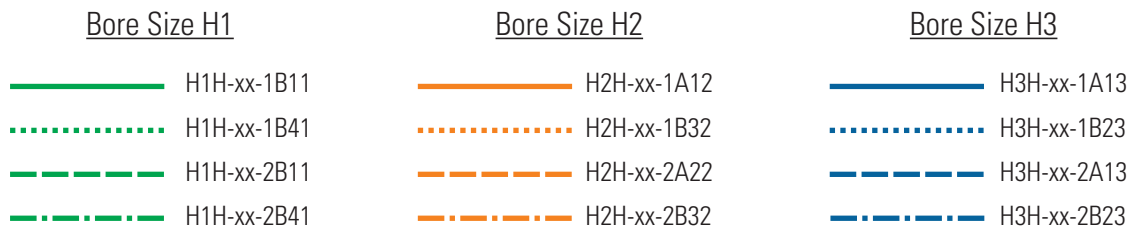
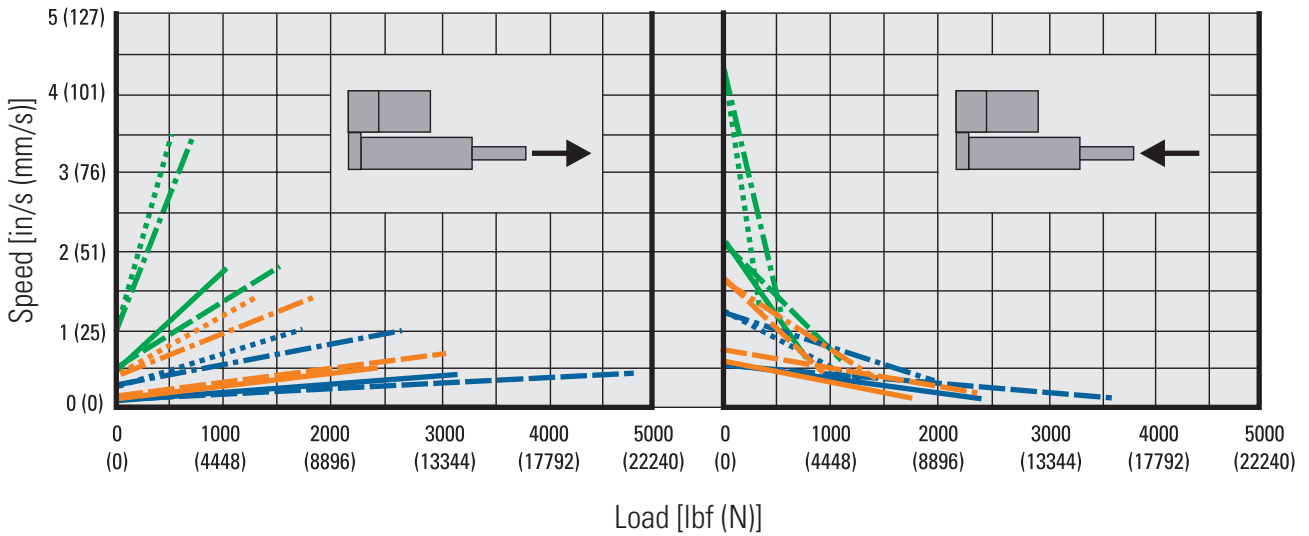

Load vs. Current

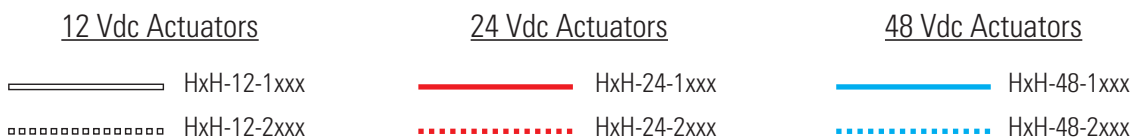
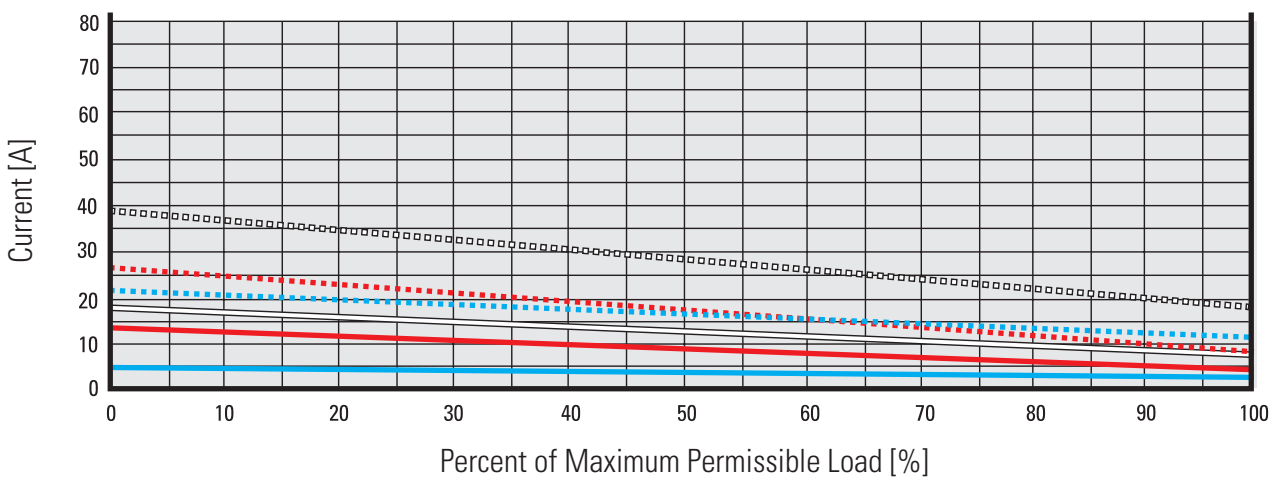



Sizing of Motor, Pump and Power Supply

N

Load vs. Speed @ Extension

Load vs. Speed @ Retraction

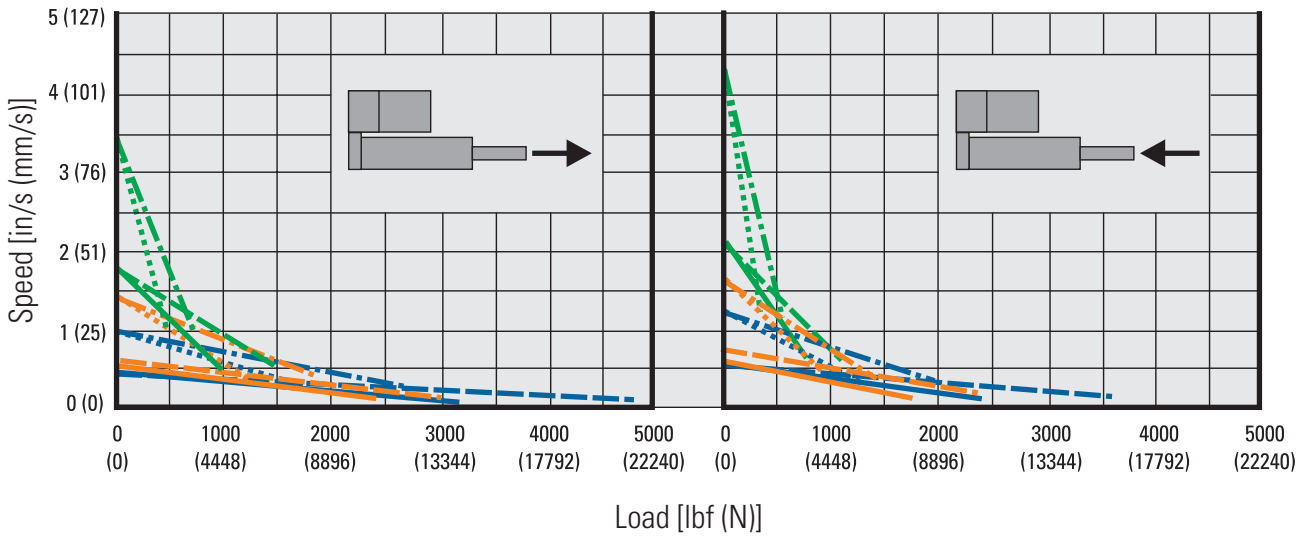

Bore Size H1

Bore Size H2

Bore Size H3

- H1N-xx-1B11
- ⋯ H1N-xx-1B41
- - - H1N-xx-2B11
- · - · H1N-xx-2B41

- H2N-xx-1A12
- ⋯ H2N-xx-1B32
- - - H2N-xx-2A22
- · - · H2N-xx-2B32

- H3N-xx-1A13
- ⋯ H3N-xx-1B23
- - - H3N-xx-2A13
- · - · H3N-xx-2B23

Load vs. Current

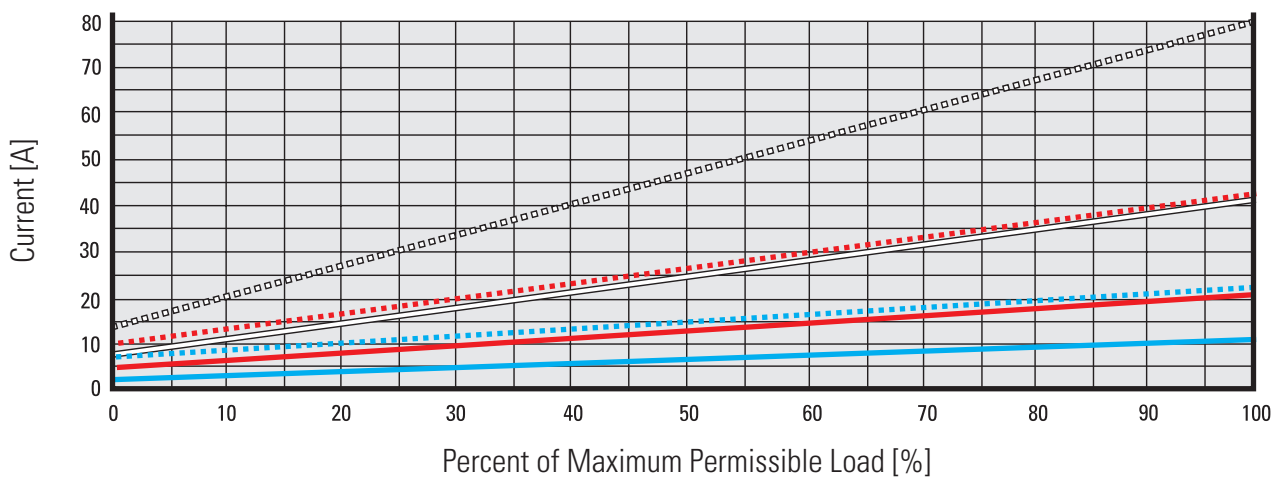

12 Vdc Actuators

24 Vdc Actuators

48 Vdc Actuators

- HxN-12-1xxx
- ⋯ HxN-12-2xxx

- HxN-24-1xxx
- ⋯ HxN-24-2xxx

- HxN-48-1xxx
- ⋯ HxN-48-2xxx

Online Resources

Thomson offers a wide variety of online tools to help you in the sizing and selection process. An experienced team of engineers is also available to help size and select an H-Track model to best fit your application needs. To explore additional technical resources and options, contact customer support at www.thomsonlinear.com/cs.

H-Track on the Web

Get additional information and learn more about H-Track on this content-rich web page. www.thomsonlinear.com/h-track

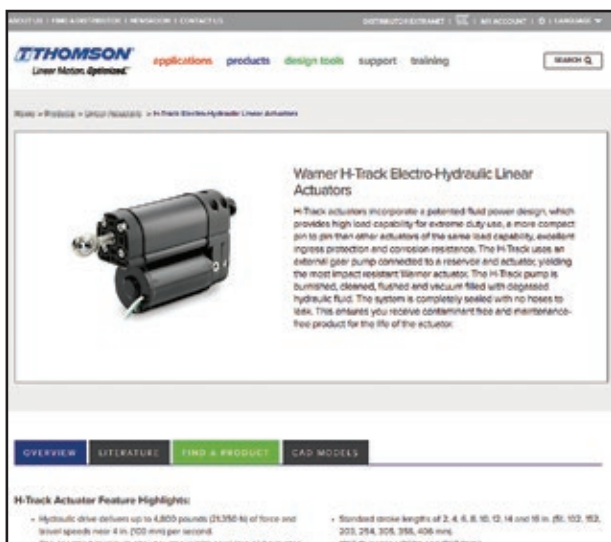

Interactive 3D CAD Models

Download free interactive 3D CAD models in the most common CAD formats. www.thomsonlinear.com/H-Track-cad

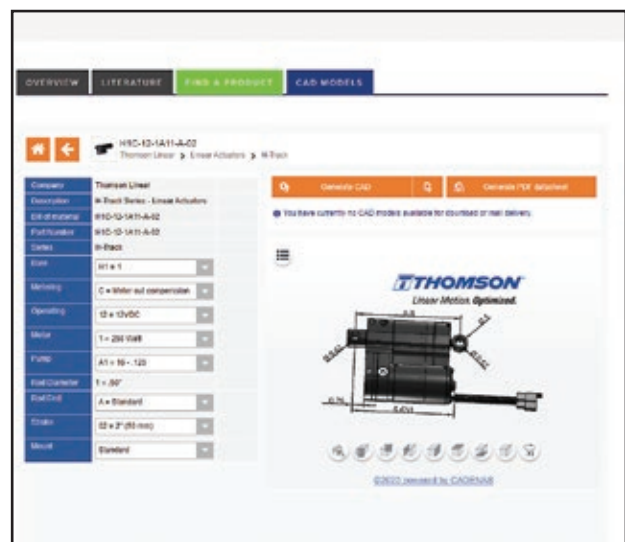

H-Track Overview Video

Learn about this electro-hydraulic actuator with this brief, informative video. www.thomsonlinear.com/H-Track-video





Frequently Asked Questions

What is the typical life of an actuator?

Life is a function of load and stroke length. Please contact customer support for more information.

What are the most common reasons for premature actuator failure?

Side load due to incorrect mounting, shock loading, exceeding the duty cycle and incorrect wiring are the most prominent causes of premature failure.

Is H-Track maintenance free?

Yes, it never requires lubrication, maintenance or adjustment for wear.

What are IP ratings?

Ingress Protection (IP) ratings are commonly referenced standards that classify electrical equipment using standard tests to determine resistance to ingress of solid objects (first digit) and liquids (second digit). See the IP Ratings table below.

Is H-Track suitable for tough environments such as washdown or extreme temperatures?

Yes. H-Track actuators are designed for washdown and have passed 200 hours of salt spray tests. They can operate in temperatures ranging from -20 to +65°C (-20 to +150°F).

How is the duty cycle determined?

The duty cycle = on time / on time + off time. For example, if H-Track is powered for 15 seconds and then off for 45 seconds, the duty cycle for that minute would be 25%. All models are rated to 25% at full load, and an ambient temperature of 25°C (77°F). If load and/or ambient temperature are lower, then the duty cycle can exceed 25%. At higher temperatures, the duty cycle will be lower.

Can H-Track be side loaded?

No. A proper design of the application should eliminate any side loads.

IP Rating (EN60529)		
Code	First Digit Definition	Second Digit Definition
0	No protection.	No protection.
1	Protected against solid objects over 50 mm.	Protected against vertically falling drops of water.
2	Protected against solid objects over 12.5 mm.	Protected against vertically falling drops of water, if the case is disposed up to 15° from vertical.
3	Protected against solid objects over 2.5 mm.	Protected against vertically falling drops of water, if the case is disposed up to 60° from vertical.
4	Protected against solid objects over 1 mm.	Protected against splash water from any direction.
5	Limited protection against dust ingress (no harmful deposits).	Protected against low-pressure water jets from any direction. Limited ingress permitted.
6	Totally dust protected.	Protected against high-pressure water jets from any direction. Limited ingress permitted.
7	–	Protected against short periods of immersion in water.
8	–	Protected against long, durable periods of immersion in water.
9K	–	Protected against close-range, high-pressure and high-temperature spray downs.

Is it possible for a load to back-drive the extension tube?

H-Track is self locking up to at least the maximum static load. Higher static load may result in damage and back driving.

What is the difference between a tension and a compression load?

A tension load tries to stretch the actuator, while a compression load tries to compress it. With bi-directional loads, the end play of the actuator extension tube may need to be taken into consideration when using the actuator for positioning tasks.

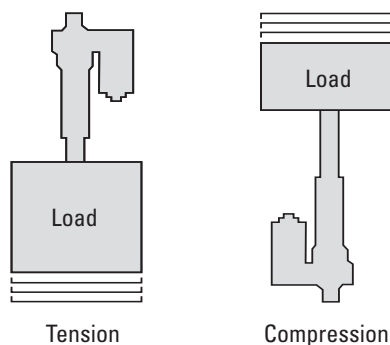

What is the range of input voltage an H-Track can operate with?

A 12 Vdc version will accept 9 – 16 Vdc, a 24 Vdc 18 – 32 Vdc and a 48 Vdc 36 – 64 Vdc. Outside of these limits, operation may be erratic and the actuator permanently damaged.

Is H-Track protected against overheating?

Yes, the motor incorporates a thermal switch in the windings to shut off the actuator motor in case of overheating or high overcurrent.

Can the speed of an H-Track be adjusted by changing the input voltage?

Yes, as long as the voltage is within the acceptable input voltage limits.

What is the inrush current?

The inrush current is a short current peak that appears at the start of an actuator as the motor tries to get the load moving. Typically, the inrush current will last between 75 – 150 milliseconds and can be up to three times higher than the current for the actuator and load. Batteries have no problem delivering the inrush current, but if using an AC power supply, it is important to size it to handle the inrush current.

What special mounting considerations does the H-Track require?

There is no restraining torque that needs to be considered as H-Track is internally restrained. However, the actuator must be mounted so that there are no side loads acting on the extension tube.

What is the maximum travel speed?

The travel speed of an H-Track actuator is a linear function of the load. To determine the speed at a certain load and direction, consult the load vs. speed diagrams on pages 18 - 20. If a higher linear travel speed is required, a simple mechanical linkage can be employed.

EUROPE

United Kingdom

Thomson
Office 9, The Barns
Caddsdwn Business Park
Bideford, Devon, EX39 3BT
Phone: +44 1271 334 500
E-mail: thomson.europe@regalrexnord.com

Germany

Thomson
Nürtinger Straße 70
72649 Wolfschlugen
Phone: +49 7022 504 403
Fax: +49 7022 504 405
E-mail: thomson.europe@regalrexnord.com

France

Thomson
Phone: +33 243 50 03 30
E-mail: thomson.europe@regalrexnord.com

Italy

Thomson
Via per Cinisello 95/97
20834 Nova Milanese (MB)
Phone: +39 0362 366406
Fax: +39 0362 276790
E-mail: thomson.italy@regalrexnord.com

Sweden

Thomson
Estridsväg 10
29109 Kristianstad
Phone: +46 44 590 2400
Fax: +46 44 590 2585
E-mail: thomson.europe@regalrexnord.com

USA, CANADA and MEXICO

Thomson
203A West Rock Road
Radford, VA 24141, USA
Phone: 1-540-633-3549
Fax: 1-540-633-0294
E-mail: thomson@regalrexnord.com
Literature: literature.thomsonlinear.com

ASIA

Asia Pacific

Thomson
E-mail: thomson.apac@regalrexnord.com

China

Thomson
Rm 805, Scitech Tower
22 Jianguomen Wai Street
Beijing 100004
Phone: +86 400 606 1805
Fax: +86 10 6515 0263
E-mail: thomson.china@regalrexnord.com

India

Kollmorgen – Div. of Altra Industrial Motion
India Private Limited
Unit no. 304, Pride Gateway,
Opp. D-Mart,
Baner Road, Pune, 411045
Maharashtra
Phone: +91 20 67349500
E-mail: thomson.india@regalrexnord.com

South Korea

Thomson
3033 ASEM Tower (Samsung-dong)
517 Yeongdong-daero
Gangnam-gu, Seoul, South Korea (06164)
Phone: + 82 2 6001 3223 & 3244
E-mail: thomson.korea@regalrexnord.com

SOUTH AMERICA

Brazil

Thomson
Av. João Paulo Ablas, 2970
Jardim da Glória - Cotia SP - CEP: 06711-250
Phone: +55 11 4615 6300
E-mail: thomson.brasil@regalrexnord.com

www.thomsonlinear.com

H-Track_BRUK-0035-04 | 20230622SK
Specifications are subject to change without notice. It is the responsibility of the product user to determine the suitability of this product for a specific application. All trademarks property of their respective owners. © 2023 Thomson Industries, Inc.

 **THOMSON**[®]

Linear Motion. Optimized.™

A REGAL REXNORD BRAND